

THS265

Cutters

- CW- Type: Cutting die with ribbon steel for soft samples
- CH- Type: Steel cutting die for hard thick samples
- CSS-Type: Cutters for metal

Presses

- Manuel hand presses (p. 4)
- Hydraulic press (pp.5-6)



THS265 Cutters

THS265-CW

- Cutting die with ribbon steel
- For 0-3 mm thick soft samples of plastic, cardboard, foam, leather, textiles, etc.
- Foam to keep sample and remove from knife
- Wooden base frame, standard dimensions: 175 x 75 mm, 200 x 75 mm, 220 x 80 mm
- Scope of delivery: cutting die incl. aluminium plate

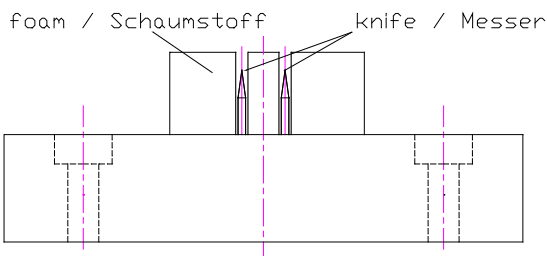

THS265-CH

- Hardened steel cutting die
- For 0-10 mm thick samples of plastic, cardboard, foam, leather, textiles, etc.
- Ejector + pin for press
- Scope of delivery: cutting die incl. steel plate



THS265-CSS-AxB-GDE

- Heavy cutter
- For thin metal foils, steel sheets, etc. up to max. 2 mm thick



THS265-CSS-127x63-ISO6892-T2-GDE

Sample size 205x35x1mm cutting force 235 kN

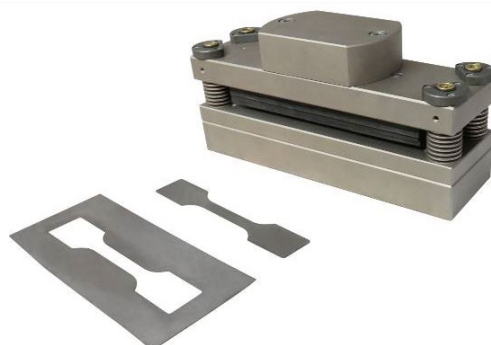

Standard shapes for THS265-CW and THS265-CH:

Bone-shape

Item no.: THS265-CW-AxB ribbon steel cutter

Item no.: THS265-CH-AxB

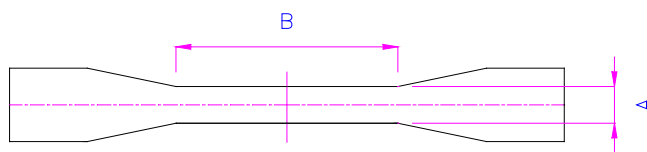

Rectangular shape

Item no.: THS265-CWR-AxB ribbon steel cutter

Item no.: THS265-CHR-AxB

A=B: square shape

Item no.: THS265-CWQ ribbon steel cutter

Item no.: THS265-CHQ

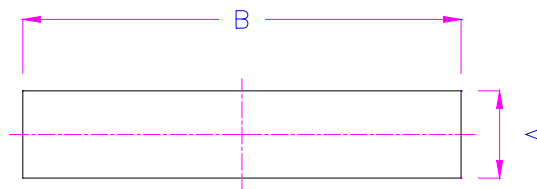

V-shape

Item no.: THS265-CWV-AxB ribbon steel cutter

Item no.: THS265-CHV-AxB

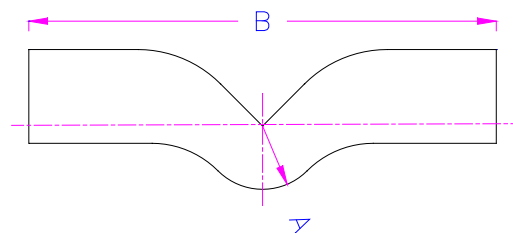

Circular shape

Item no.: THS265-CWC ribbon steel cutter

Item no.: THS265-CHC

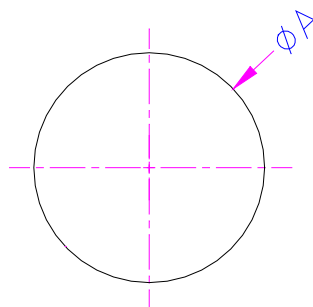

Further shapes*

Item no.: THS265-CWS-AxB ribbon steel cutter

Not possible with THS265-CH cutters

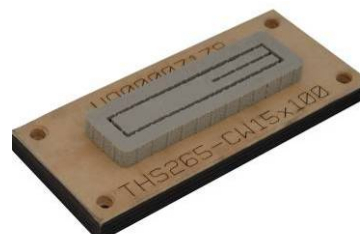
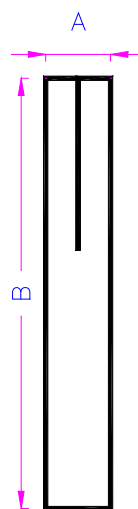

*Further shapes on request.

THS265-CW and THS265-CH can be delivered for any standard, e.g. ISO34, ISO37, ISO527, ASTM-D412, ASTM-D624, ASTM-D635, ASTM-D638, ASTM-D1004, EN455, EN527, ABNT NBR15557, DIN53504, etc.

Adapter + platens for direct use in tensile tester – no press needed

Including nylon counter plate (120x220 mm)

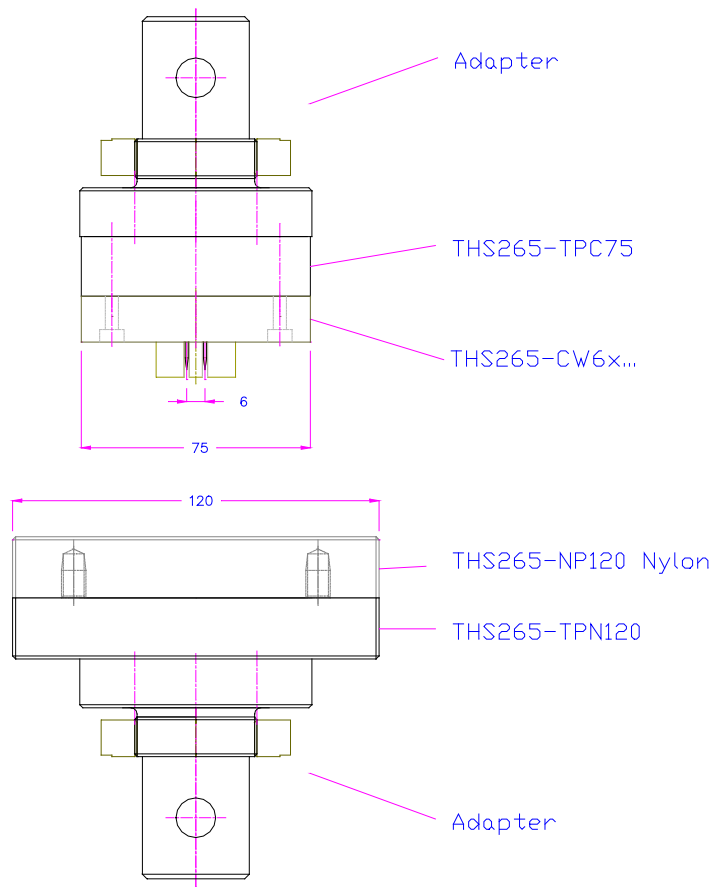

THS265-CW6x33+Am35

e.g. cutting die with ribbon steel + adapter 35 mm for direct use in tensile tester



THS265-CH6x33+sample ejector+Am317

e.g. hardened steel cutting die + adapter 31.7 mm for direct use in tensile tester

Presses

Manuel hand presses

including nylon counter plate (120x220 mm)

Item no.:	THS265-P8	THS265-P17	THS265-P26
Compression force:	8 kN	17 kN	26 kN
Weight:	22 kg	35 kg	46 kg
Dimensions:	Ca. 160 x 230 x 410 mm	Ca. 170 x 270 x 415 mm	Ca. 140 x 310 x 475 mm
Handle length:	40 mm	60 mm	60 mm
Adjustable working height:	50 – 200 mm	75 – 180 mm	70 – 250 mm
Column height:	Ca. 410 mm	Ca. 415 mm	Ca. 475 mm
Base area:	Ca. 160 x 230 mm	Ca. 130 x 260 mm	Ca. 140 x 310 mm

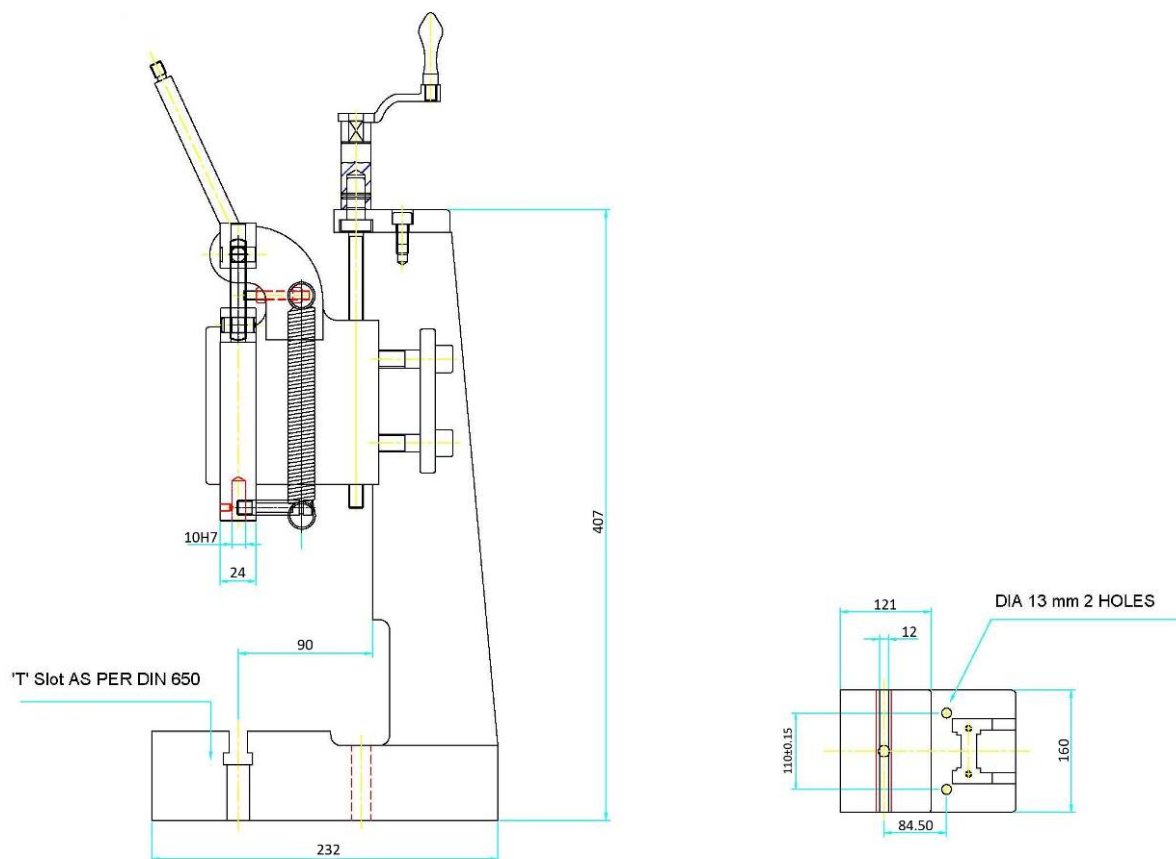

THS265-P8

Hydraulic press 100 kN, 520 bar incl. pump

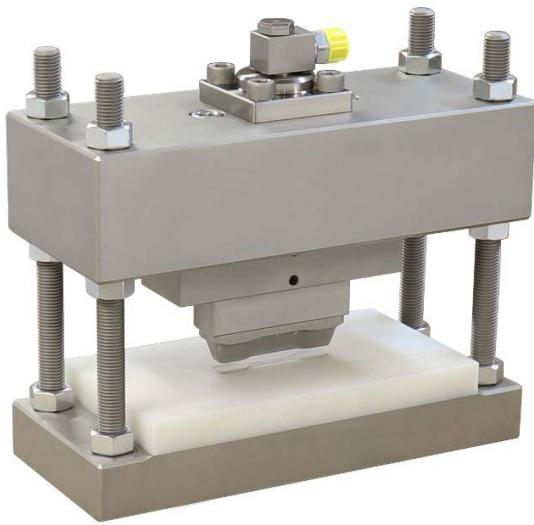

Item no.: THS265-HP100

Cutting height can be precisely adjusted to a sample height, so that dangerous openings can be avoided.

Cutting speed is slow making the process safer.

Max sample thickness 14 mm

 [https://youtu.be/d_OnLk7 -SA](https://youtu.be/d_OnLk7-SA)

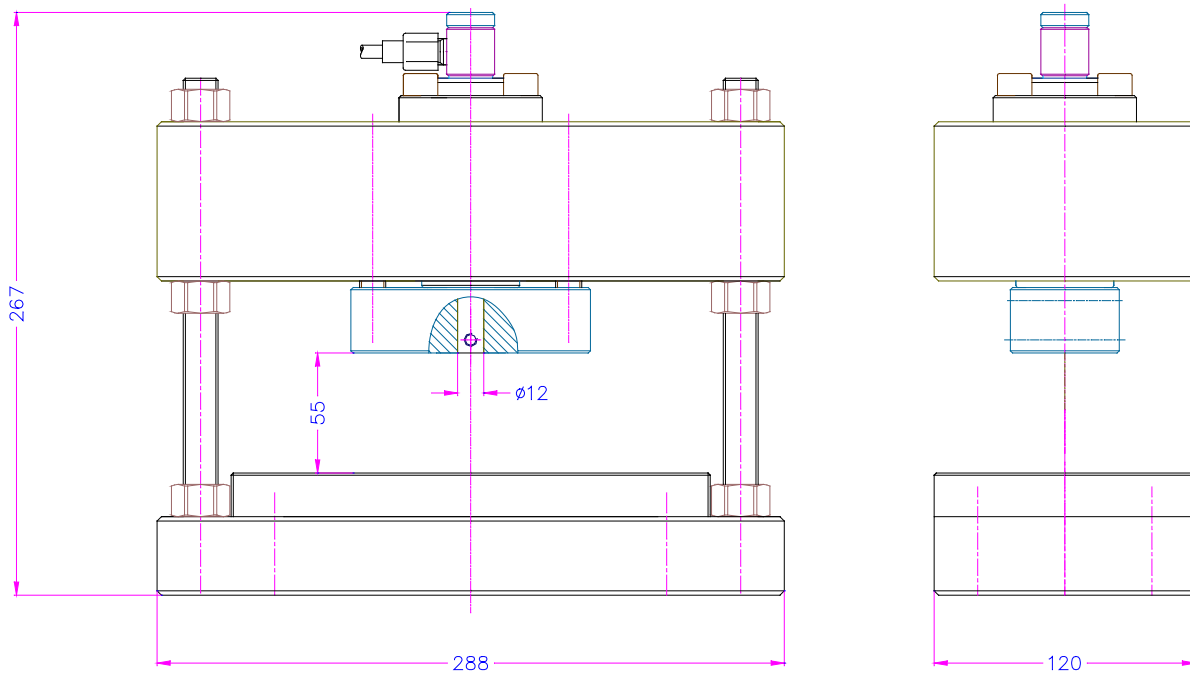

Cutting force

If you do not know the cutting force you can send us your sample and we will determine the cutting force for you.

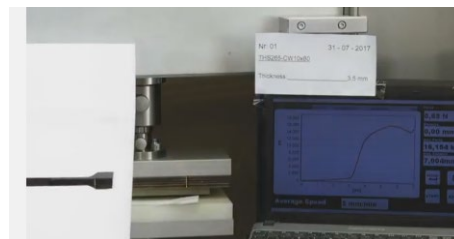

 <https://youtu.be/CXdLZ0sQyqo>

Air hydraulic pump for THS265-HP100



Max. pressure:	700 bar
Tank size:	0.9 l
Output flow rate:	0.13 l/min at 700 bar; 0.5 l/min at 0 bar
Dimensions:	450x190x190 mm (LxWxH)
Weight:	9 kg
Scope of supply:	1 pump incl. high pressure hose (1.8 m long)

Videos



Cutting copper stripe with P8 – 8 kN hand press

<https://youtu.be/qhMYJog5O3g>

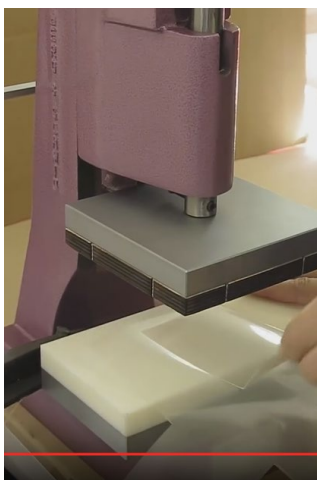

Cutting a square sample

<https://youtu.be/D0ueSwq0nb4>

THS265-CWQ100